

## User's Manual

## Appearance and buttons

1. LCD display screen

2. Power/Mode

3. WIFI Indicator (red)

4. Power indicator/Charging indicator

(Blue)

5. Wifi/Menu

6. Busy (red)

7. Shutter /OK key

8. Camera Lens\*2 (220°)

9. Triangle nut

10. Access flap (USB, TF)

11. Loudspeaker

12. Microphone

13. Lanyard hole

14. Reset Button

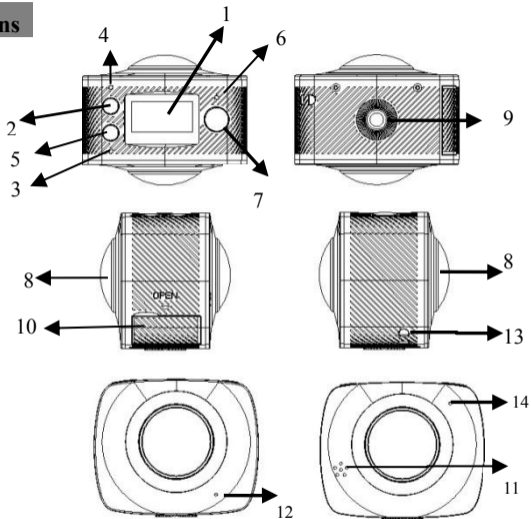

## How to use your Wifi camera?

1. First, insert a micro SD or micro SDHC card; see the picture on the right;

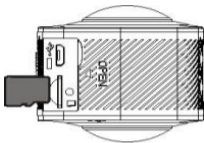

SDHC above Class 6 is recommended. When the professional mode is on for video recording, Class 10 is recommended for use.

**Please close the camera when plug-in or pull-out the card.**

### 2. Turn-on & Turn-off:

Turn-on: Press the on/off button  and hold for about 2 seconds. With a sound of “Be-” from the buzzer, LCD display screen will be on (default mode: video recording). **Power indicator in red is normally on.**

Power saving mode: When the camera is not under operation for 1 minute (system default), it will be in the

power saving mode. The LCD display screen will be off automatically. The camera can be activated when any button is pressed.

Turn-off: Press the button  and hold for about 3 seconds when the camera is not in operation. With a sound of “Be-” from the buzzer, the camera will be off.

The camera will be automatically off when it is in power saving mode for 3 minutes (system default). “GOODBYE” will be on the LCD screen when it is off.

### **3. Charge the camera**

Built-in rechargeable lithium battery is used for the camera:

The camera can be charged when it is connected to the computer USB with a USB cable. The power indicator will be blue when it is charging. It shall take 4 hours because of the limited electric current of the computer. The blue light will be off when charging is completed.

### **4. Function mode conversion**

The camera has two modes, i.e. video recording and photograph shooting. They can be converted by pressing

the button on/off/MODE or through APP.

**Video recording:** (see the following pictures) press the shutter to start shooting and video recording. The buzzer will send out one sound when it starts; the busy button (red) will be twinkling during the video recording process. LCD timer starts timing. Press the button again when video recording is over.

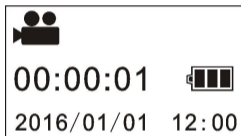
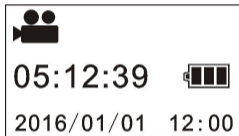

**Photograph shooting:** Short press the take-photo button to shoot photographs after it is switched to the photo-shooting mode. The buzzer will send out 1 sound and the busy button (red) will be twinkling when 1 photo is shot. The counter will countdown the photos accordingly.

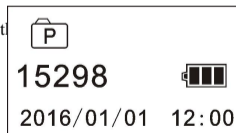

## 5. Menu operation:

Press the WIFI button for 2 seconds to activate the menu:



**Enter the menu**, short press the WIFI button to move the cursor for selection; press the shutter button for confirmation; extended press the WIFI button to cancel the setting or exit.

**Power Save:** the power saving mode has 4 settings, i.e. OFF/1min/3min/5min. When the setting-time is up, the camera will enter power saving mode and the screen will be off.

**Date & Time:** system time setting

**Language:** language setting, English is by default.

**Date Stamp:** date stamp setting, OFF/Date/Date & time are optional.

**Factory Reset:** factory reset, YES/NO are optional

**System:** check for system information (software version number); check the information on the memory card

(capacity and available space)

Format: formatting the memory card, YES/NO are optional.

## **6. Watch Remote Controller:**

~~1. Watch remote controller is shown  
in the picture:~~

~~—~~

- ~~\_\_\_\_\_ 1.power~~
- ~~\_\_\_\_\_ 2.video button~~
- ~~\_\_\_\_\_ 3.photo button~~
- ~~\_\_\_\_\_ 4.button indicator(red)~~
- ~~\_\_\_\_\_ 5.watchband~~
- ~~\_\_\_\_\_ 6.watch clasp~~

~~—2. Instructions:~~

~~The camera can be operated for starting up, video recording, photograph shooting and shutting down when the watch remote controller is used within the distance of 30 meters. Press the related button on the controller for videos, photos or turning off.~~

~~P.S.: the indicator on both sides will be on in red if any button is pressed.~~

—3. Turn-on & turn-off the camera—

Turn-on: press  button, stop pressing till the indicator is off. The camera is on with a sound sent out by the buzzer.

Turn-off: press  button, the camera will be off with a sound sent out by the buzzer.

—4. Battery replacement:—

—Battery should be replaced when the power is low. Open the battery case carefully with a coin to avoid serape.—

## APP (for Android and iOS)

### I. How to get the APP Installer?

1. For Android users, please search for “SYVR360” in the Play store and install it according to its



instructions; or scan the 2-dimentional bar code  on the graphic carton for installation.



2. For iOS users, please search for “SYVR360” in App Store and install it according to its instructions; or



scan the 2-dimensional bar code                      on the graphic carton for installation.

## II. APP Application

1. After installing SYVR360 (provided by the supplier or Internet) on the mobile phone or tablet PC,

the icon  will be shown on the screen;

2. Insert a card and turn the video camera on, press the Wi-Fi button to connect Wi-Fi, whose icon will be shown on the screen;

3. Turn on Wi-Fi on the mobile phone or tablet PC, search for AP with the signal name of TP720 (default), then connect it till the connection is successful.

4. Click the App icon  on the mobile phone or tablet PC and run related operation directly according to the reminder when the preview pictures transited to the mobile phone or tablet PC.

Notice:

1. Please insert a TF card to the video camera if you need to shoot or download pictures by mobile phone or tablet PC terminal.
2. Wi-Fi indicator will be normally on when the mobile phone or tablet PC terminal is connected to the video camera.

**When applied to the PC:**

---

The video camera has the plug and play function. When connected to a PC by the USB cable, it will automatically switch to the mobile HDD mode.

The removable disc icon will appear on “My Computer”. Your photos are stored in the folder I:\jpg (I is removable disc for this device) in the removable disc. And your videos are stored in the folder I:\video;

Notice: No need to install drivers to run its mobile HDD function if your operating system is windows 2000 or above.

## Technical Parameters

---

<b>Image sensor</b>	4 million pixel (CMOS) x2	
<b>Function Mode</b>	Video recording; photograph shooting	
<b>Camera lens</b>	F2.0 f=1.1mm	
<b>Video resolution ratio</b>	1920*960P (30fps)	
<b>Photograph resolution ratio</b>	3008*1504	
<b>File format</b>	video	H.264 (MOV)
	photo	JPG
<b>Memory Medium</b>	TF card (maximum:32GB)	
<b>USB port</b>	High-speed USB 2.0 port	
<b>Power</b>	Built-in lithium battery 14500 mAh	

